

H G F E D C B A

4

4

3

3

2

2

1

1

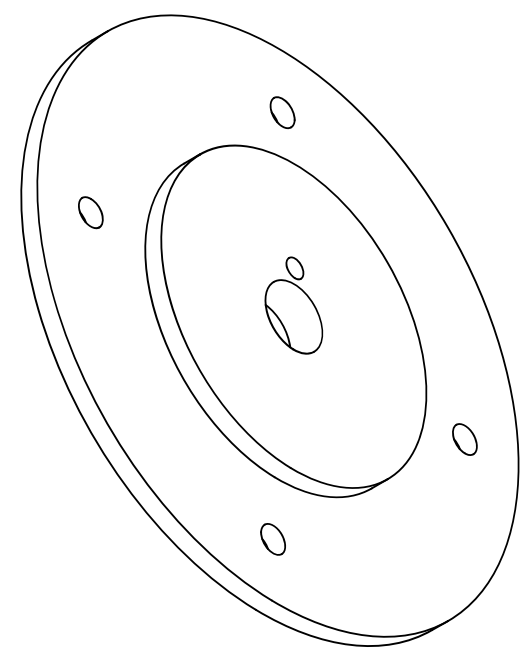
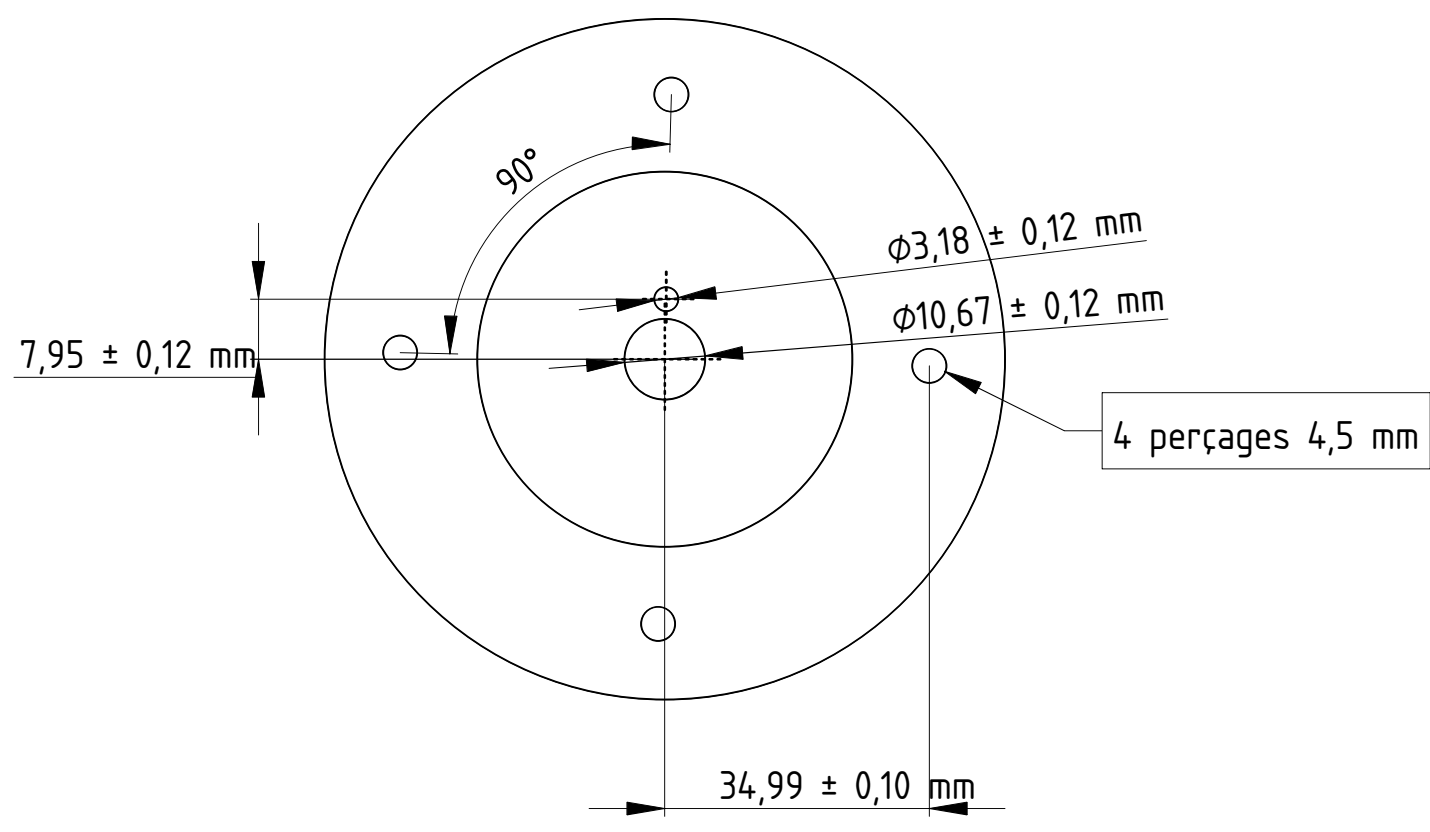

DESSINATEUR : Didier AYESTEN		Support codeur absolu Couronne d'orientation		I	_____
DATE : 26/09/2023				H	_____
VALIDÉ PAR :		SOCIÉTÉ : Particulier		G	_____
DATE :				F	_____
FORMAT : A3		VERSION : 1.1		E	_____
ÉCHELLE : 1/1	POIDS (kg) :			D	_____
COPYRIGHT		FEUILLE : 1/1		C	_____
				B	_____
				A	_____

H G F E D C B A