

X2
S235

27x4.E235
1. Tube ~~26~~x 3.5.E235

USINAGE XL
SL35

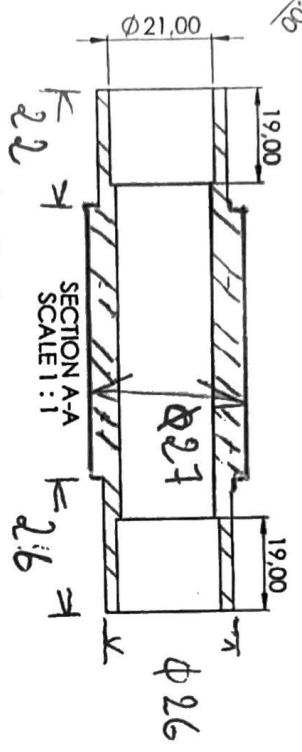
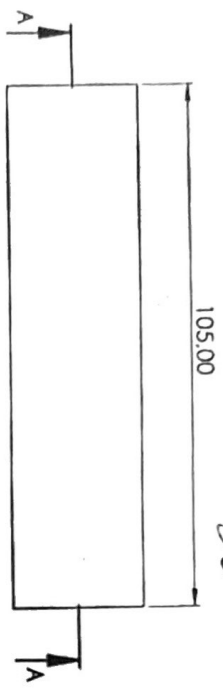
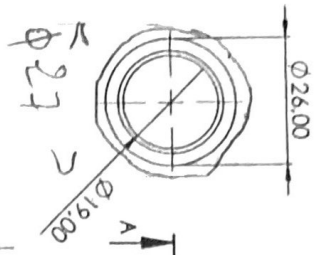

2 Pièces

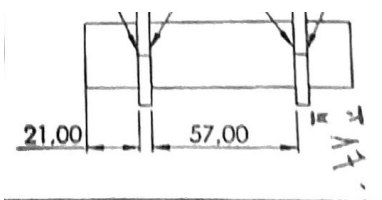

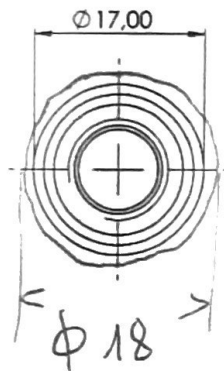

2 Pieces

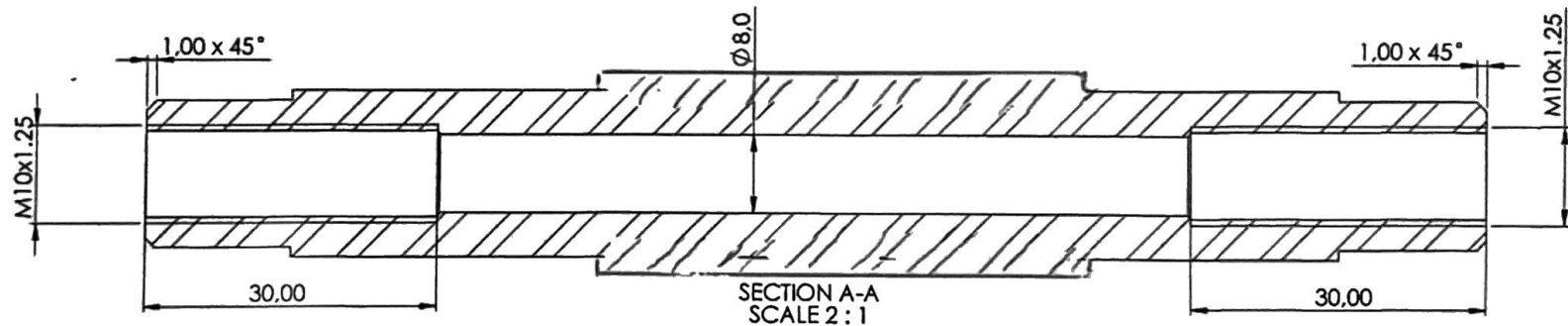
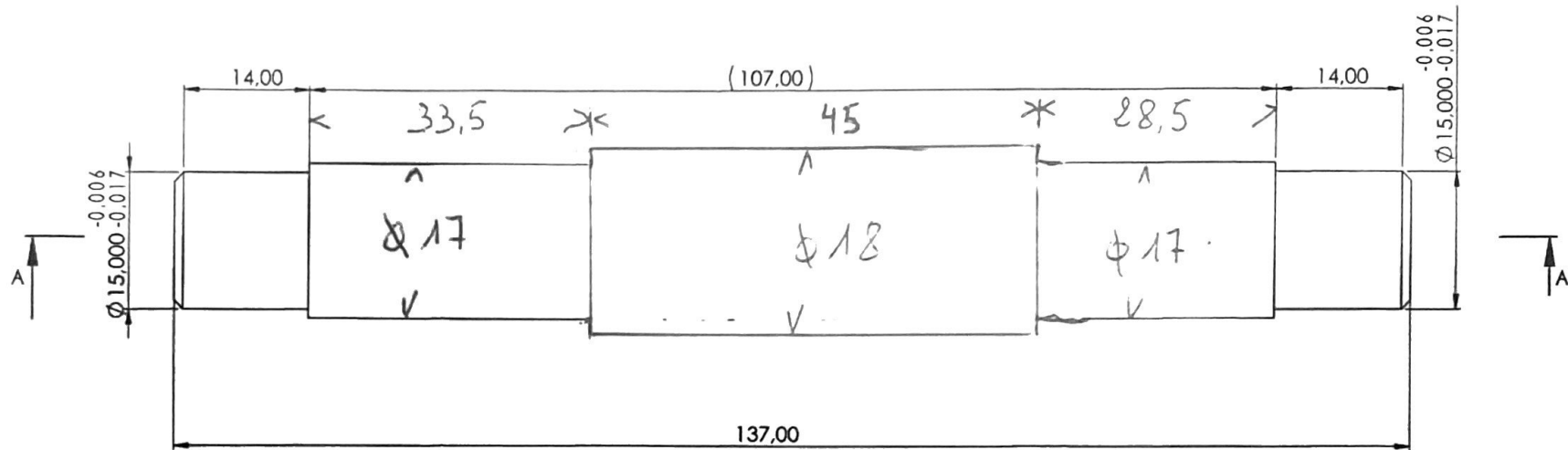

x2
S235

X2
S235

