

Coupe A-A
Echelle : 2:1

TOLERANCE GENERALE +/- 0.2
MATERIE: ALU

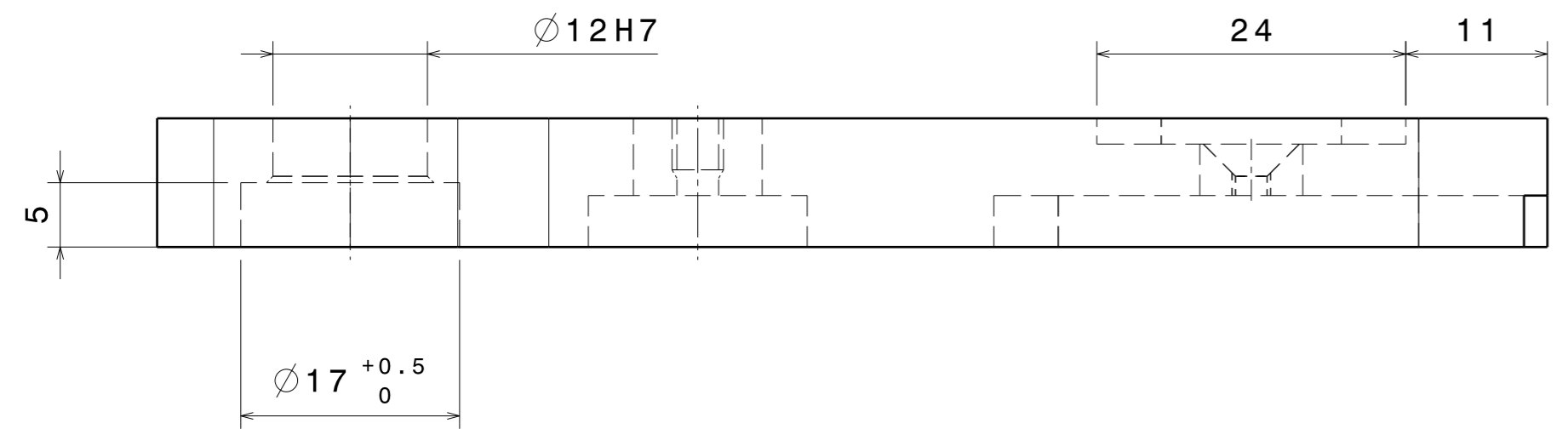
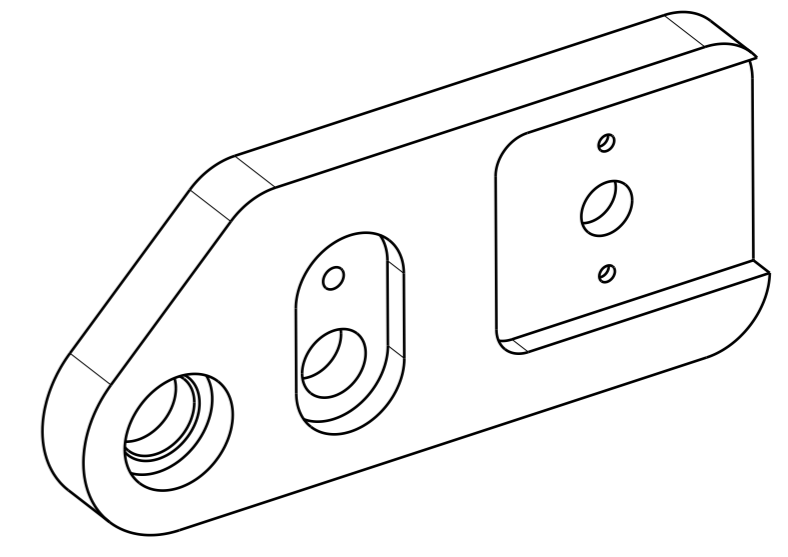

DESIGNED BY: BOUJOT	RHS FERRURE	I	-
DATE: 11/11/2019		H	-
CHECKED BY: BOUJOT	KIT MODIFICATION	G	-
DATE: 11/11/2019		F	-
SIZE: A2	004	E	-
SCALE: 2:1		D	-
WEIGHT (kg): XXX	1/1	C	-
DRAWING NUMBER: 004		B	-
SHEET: 1/1		A	-

This drawing is our property; it can't be reproduced or communicated without our written agreement.