

Front view
Scale: 1:2

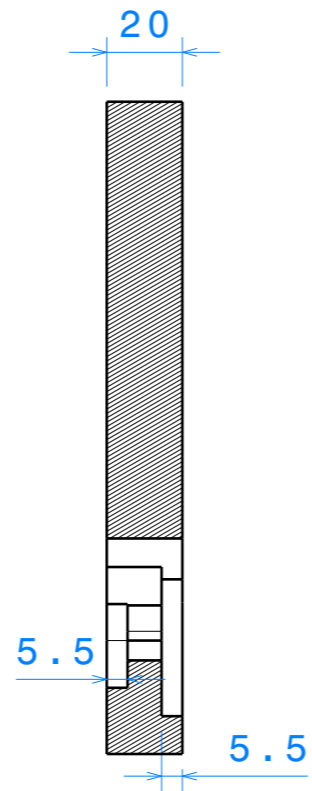

Section view A-A
Scale: 1:2

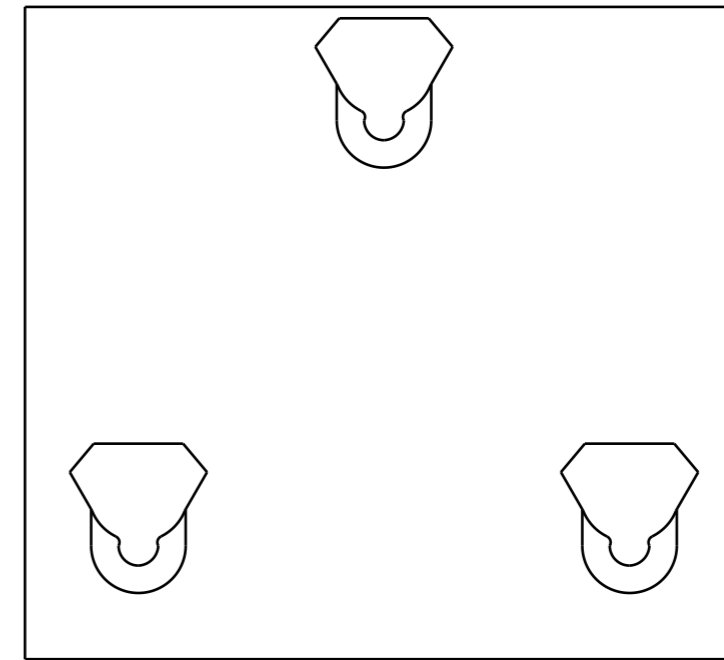

Back view
Scale: 1:2

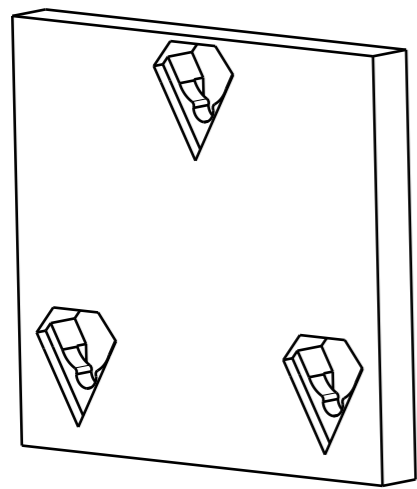

Isometric view (front)
Scale: 1:3

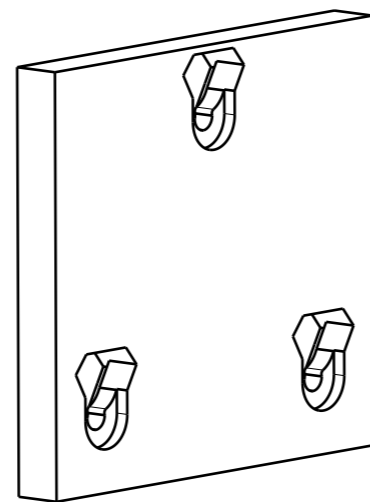

Isometric view (back)
Scale: 1:3

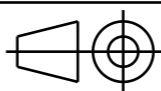
DESIGNED BY: NYD	Système de fixation DELTA		I	-
DATE: 22/12/2018			H	-
CHECKED BY: XXX			G	-
DATE: XXX	DELTA		F	-
SIZE A3		DRAWING NUMBER 001	E	-
SCALE XXX			WEIGHT (kg) XXX	D
		SHEET 1/2	C	-
			B	-
			A	-

This drawing is our property; it can't be reproduced or communicated without our written agreement.

H G F E D C B A

4

3

2

1

4

3

2

1

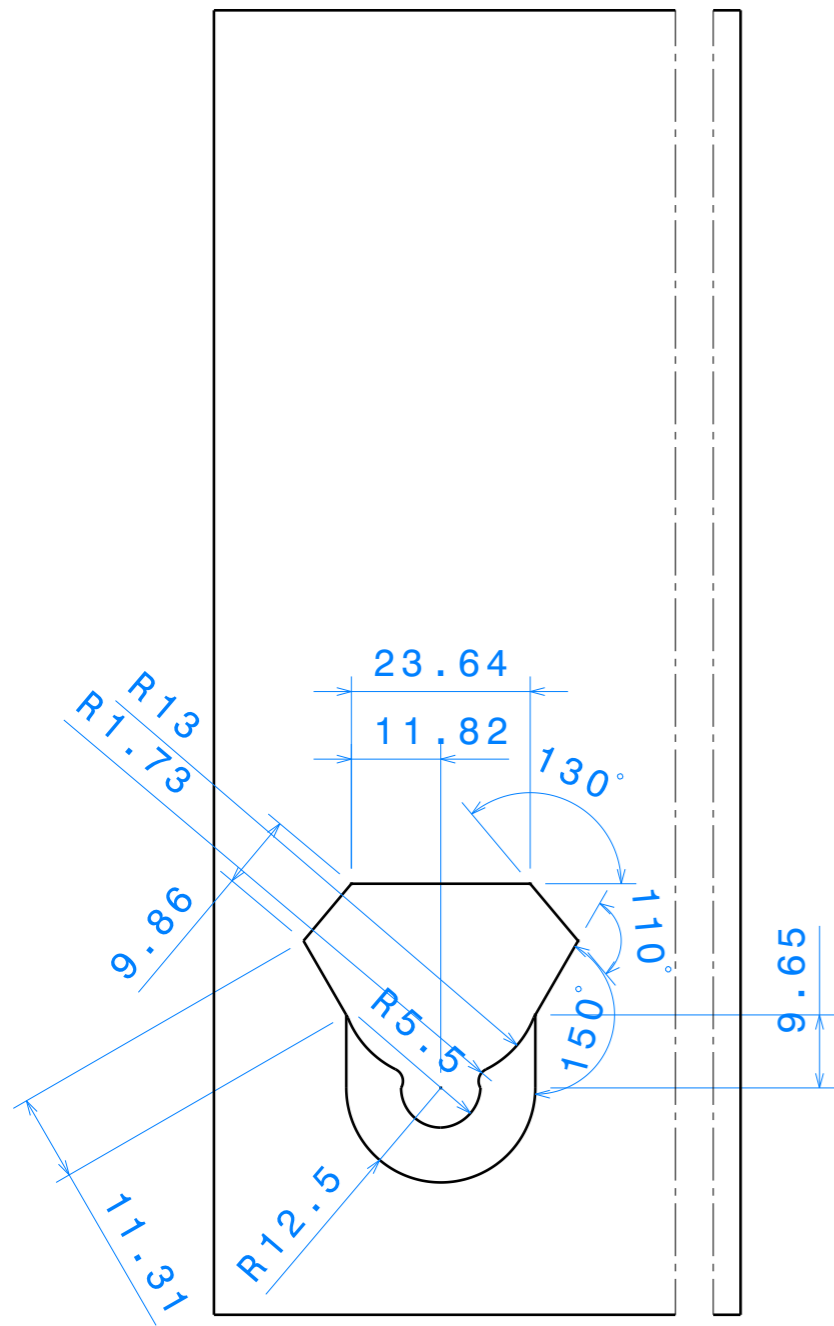

Back view
Scale: 1:1

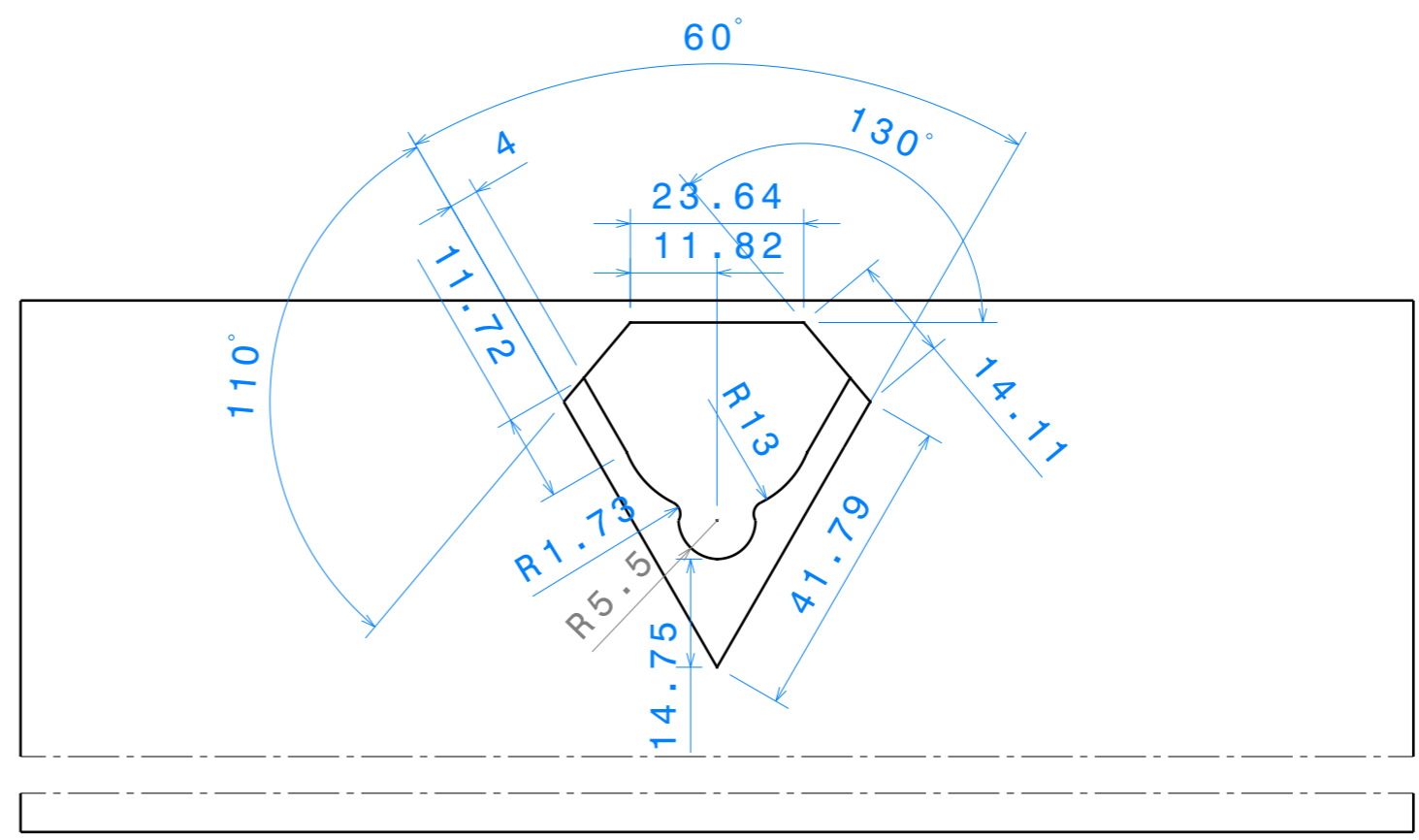

Front view
Scale: 1:1

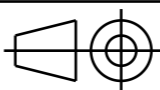
DESIGNED BY: NYD		Systeme de fixation DELTA		I	-
DATE: 22/12/2018				H	-
CHECKED BY: XXX				G	-
DATE: XXX		DELTA		F	-
SIZE: A3				E	-
SCALE: XXX	WEIGHT (kg): XXX	DRAWING NUMBER: 001	SHEET: 2/2	D	-
This drawing is our property; it can't be reproduced or communicated without our written agreement.				C	-
				B	-
				A	-

H G B A