

H G F E D C B A

4

4

3

3

2

2

1

1

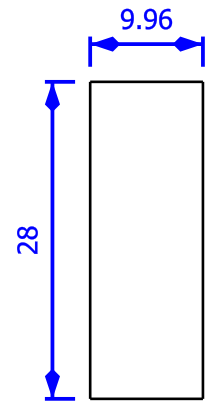
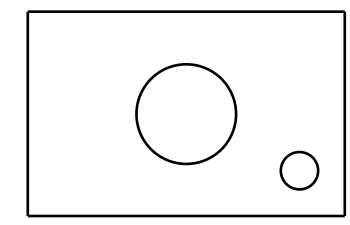
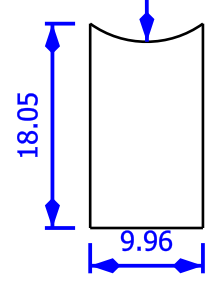
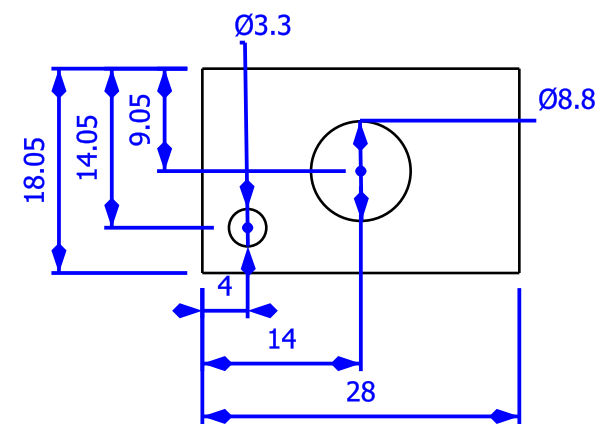
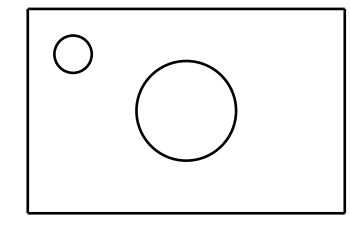
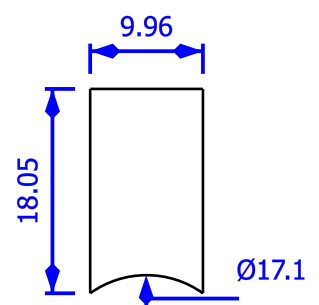
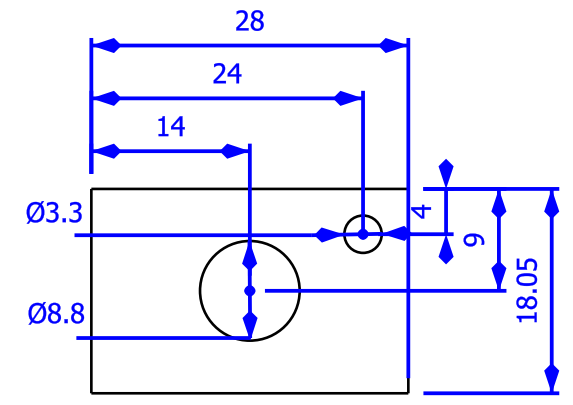
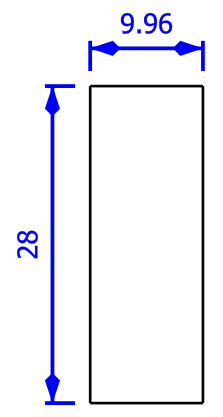

DESIGNED BY: BEGOC LUDOVIC		TROTTINETTE SUPPORT MOTEUR - PIECE CENTRALE
DATE: 07/05/2018		
CHECKED BY: BEGOC LUDOVIC		
DATE: 07/05/2018		
SIZE A3		
SCALE 1/1	WEIGHT (kg) EN MM	DRAWING NUMBER 1
		SHEET 1/1

I	-
H	-
G	-
F	-
E	-
D	-
C	-
B	-
A	-

This drawing is our property; it can't be reproduced or communicated without our written agreement.

H G F E D C B A