

Coupe A-A

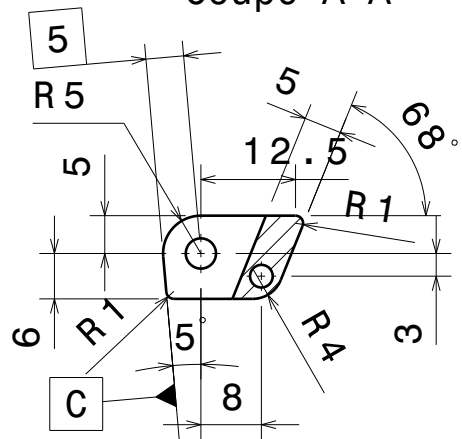

0.4 A

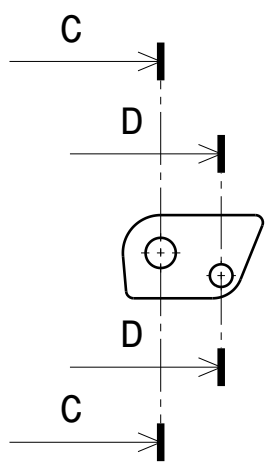

Coupe C-C

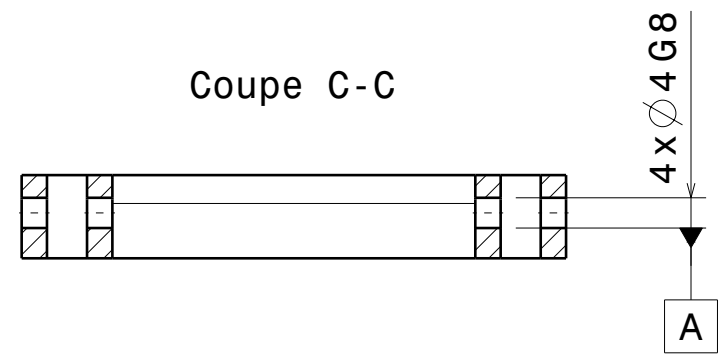

Coupe B-B

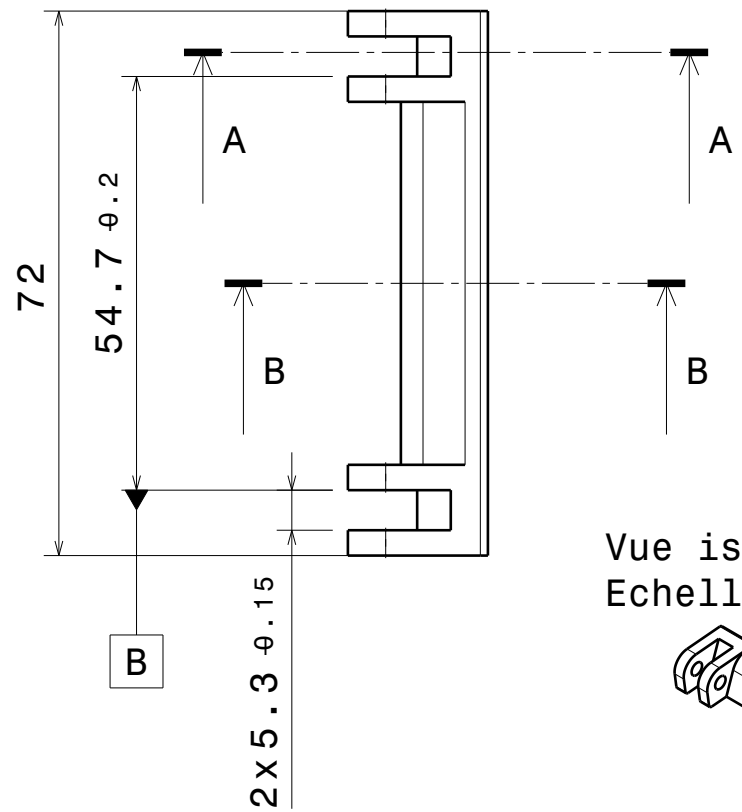
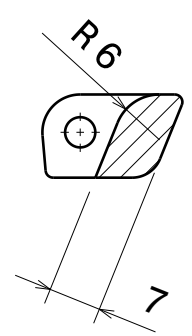

Vue isométrique
Echelle : 1:2

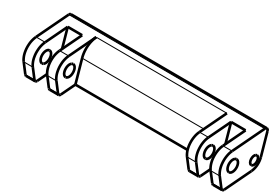

Coupe D-D

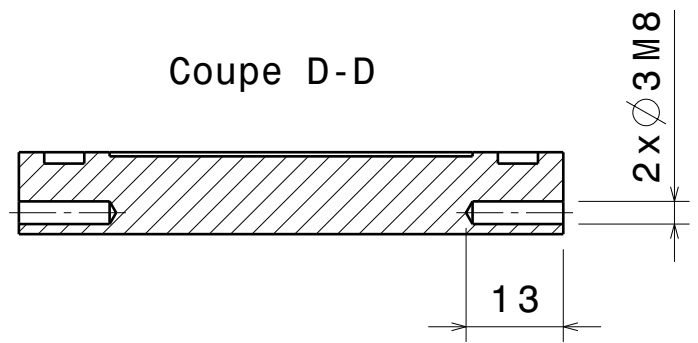

Cale 2 Couteau

Echelle : 1/1
Matiere : Aluminium
Tol Generale : +/- 0.25
Angles : +/- 1°
Indice : 02
Date : 10/05/17