

H G F E D C B A

4

4

3

3



2

2

1

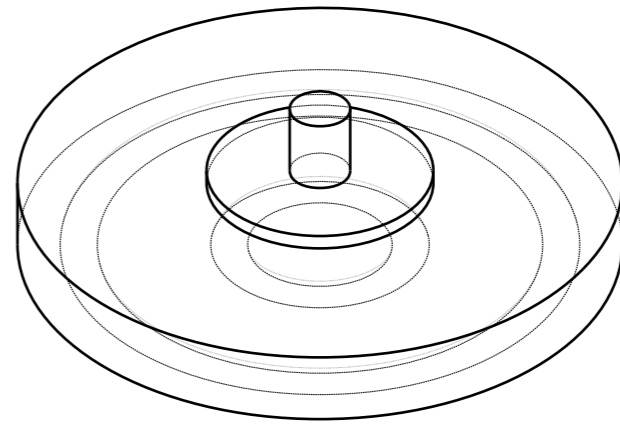
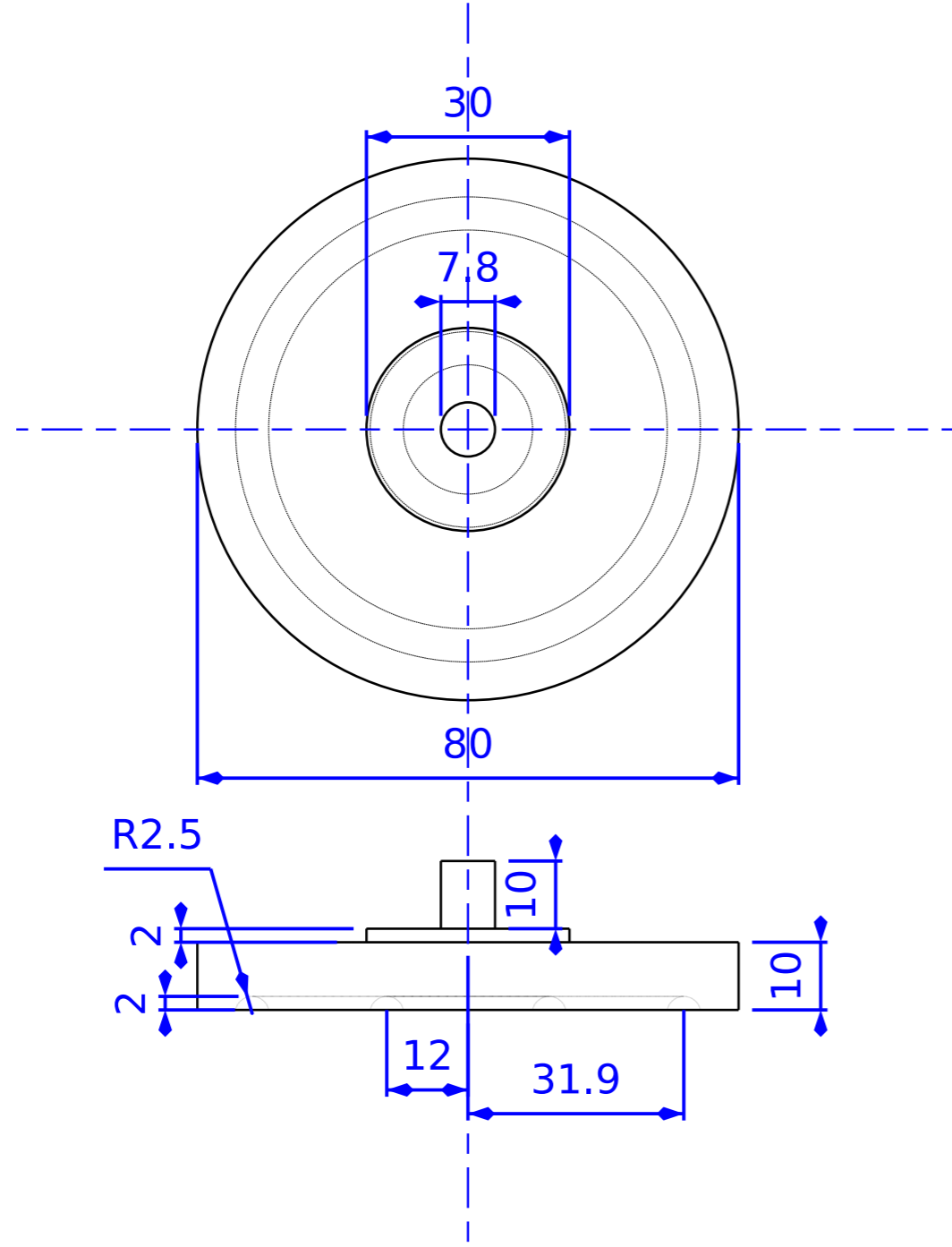
1

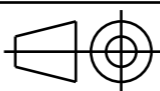

DESIGNED BY: AUTHOR NAME		TITLE		I	-
DATE: CREATION DATE				H	-
CHECKED BY: SUPERVISOR NAME		SUBTITLE		G	-
DATE: CHECK DATE				F	-
SIZE				E	-
A3				D	-
SCALE	WEIGHT (kg)	DRAWING NUMBER	SHEET	C	-
SCALE	WEIGHT	NUMBER	SHEET	B	-
This drawing is our property; it can't be reproduced or communicated without our written agreement.				A	-

H G F E D C B A