

Vue de face  
Echelle : 1:1

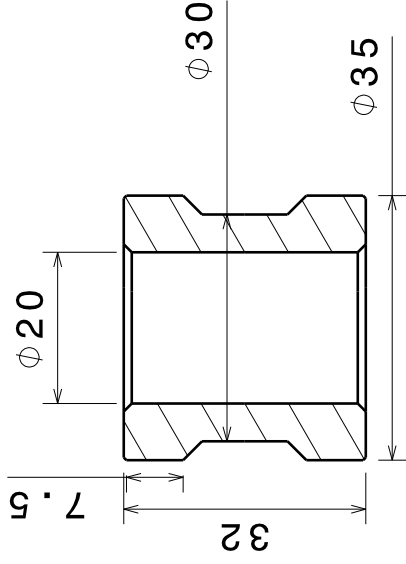

Coupe A-A  
Echelle : 1:1

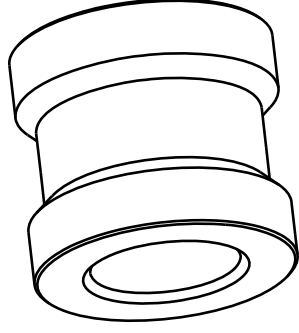

Vue isométrique  
Echelle : 1:1